

גשר אריאל שרון



צוות הפרויקט

חל"ת נתניה	מזמין הפרויקט
אילן חדד שירותי הנדסה	ניהול פרויקט
חברת מהנדסים	גאומטריה
אריה הוכברג	תנועה
גונן - אדריכלים	אדריכלות
מכטה-גאוטכניקה	יועץ ביסוס
פרופסור י. שיינמן	ייעוץ דינמיקה ויציבות
לויטן מהנדסים	בקרה
שרגא ירון	מטלורג
רולידר	קבלן ראשי
הגבעה מפעלי מתכת	קבלן הפלדות
רוקח אשכנזי מהנדסים	קונסטרוקציה

הגשר במספרים

- אורך הגשר 100 מ'
- מפתח מקסימלי 76 מ'
- רוחב הגשר 32-45 מ'
- גובה הקשת מהקרקע 20 מ'
- גבריט 6.5 מ'
- עלות הגשר כ-28 מיליון ₪

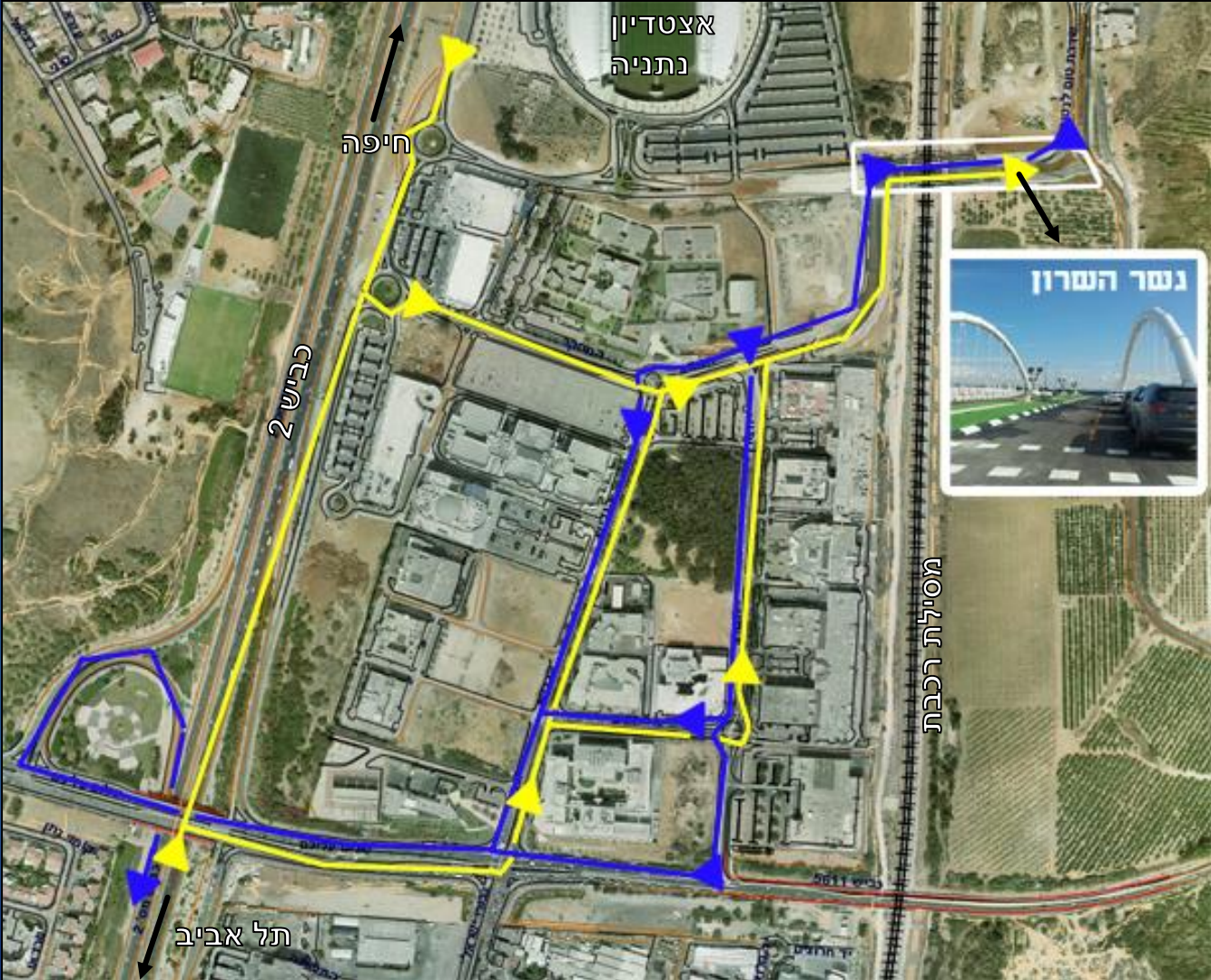



תשתיות בסביבת הגשר

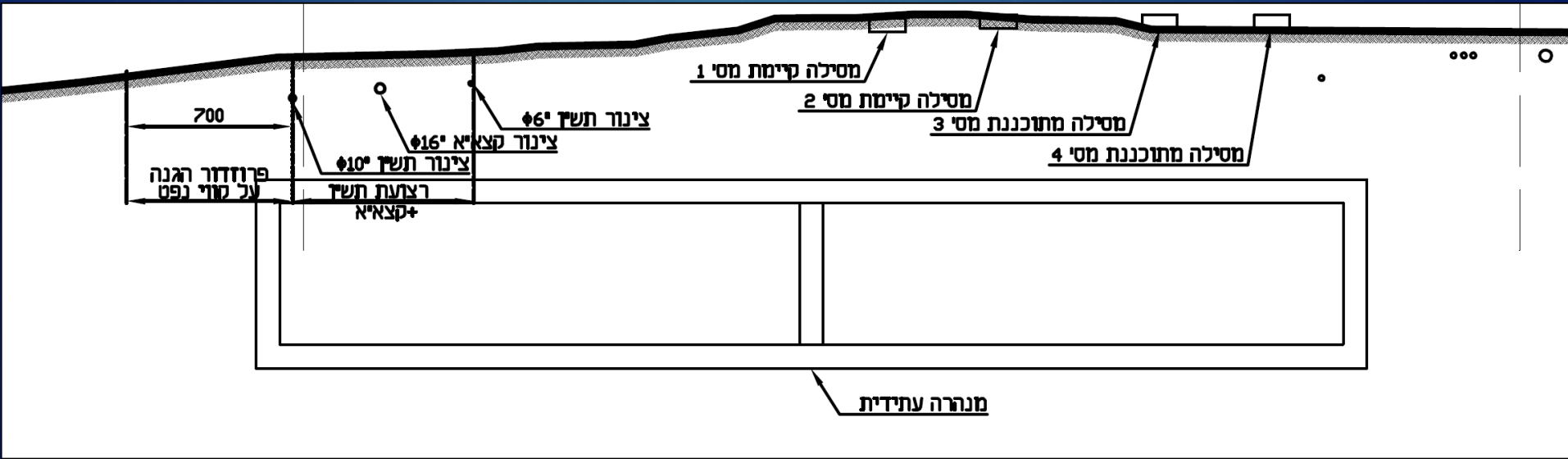

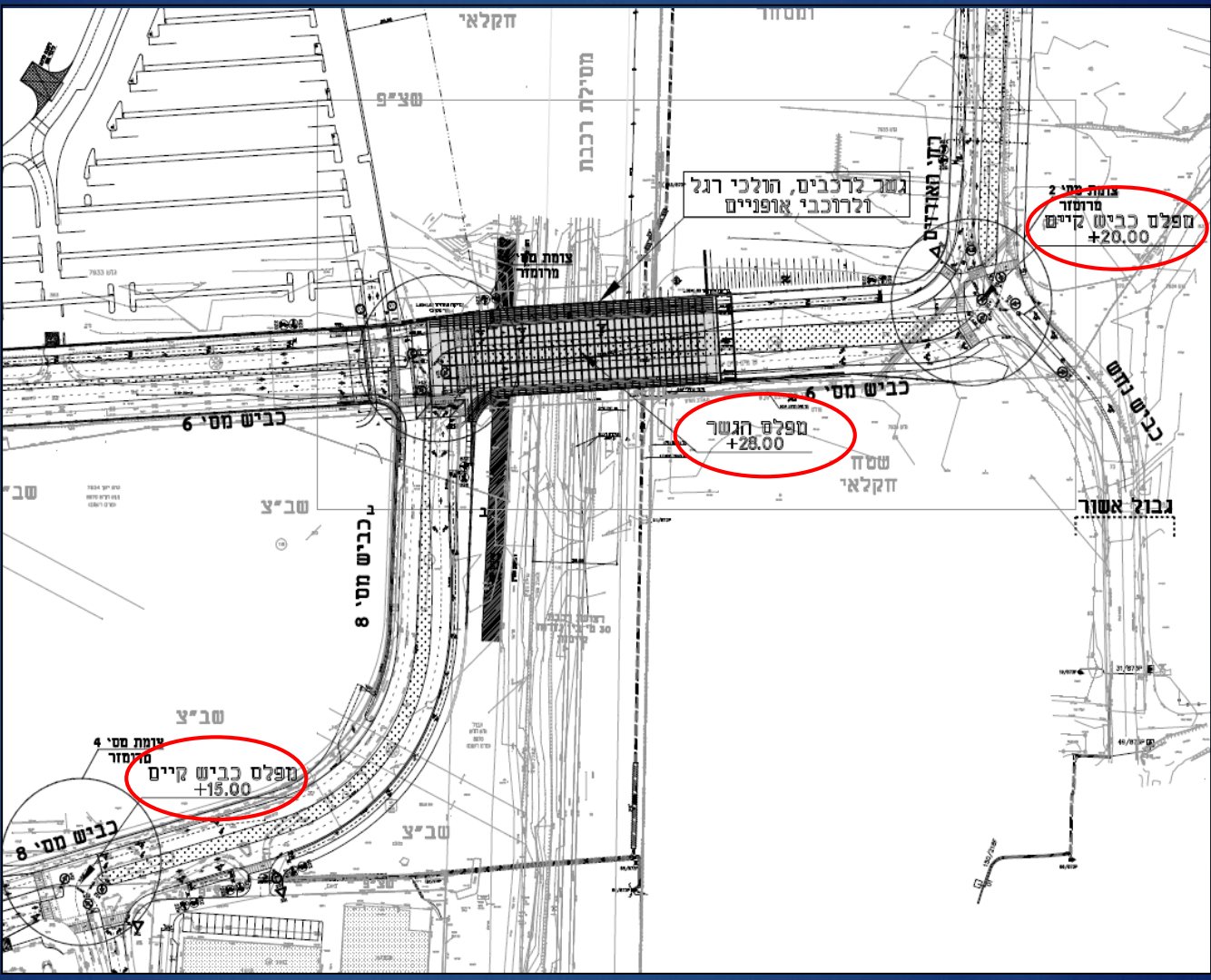

חזית

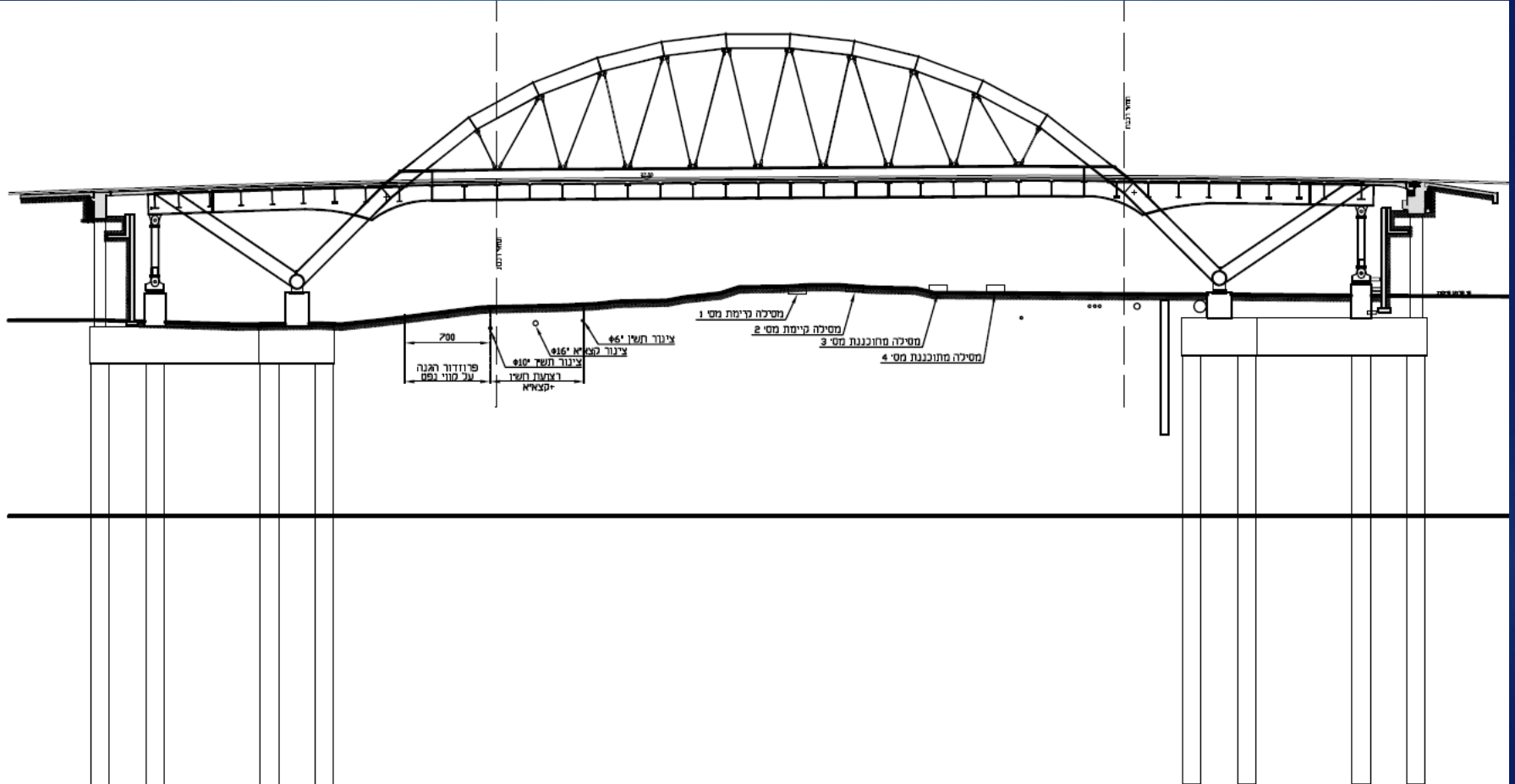

חתך רוחבי

2340

South

North

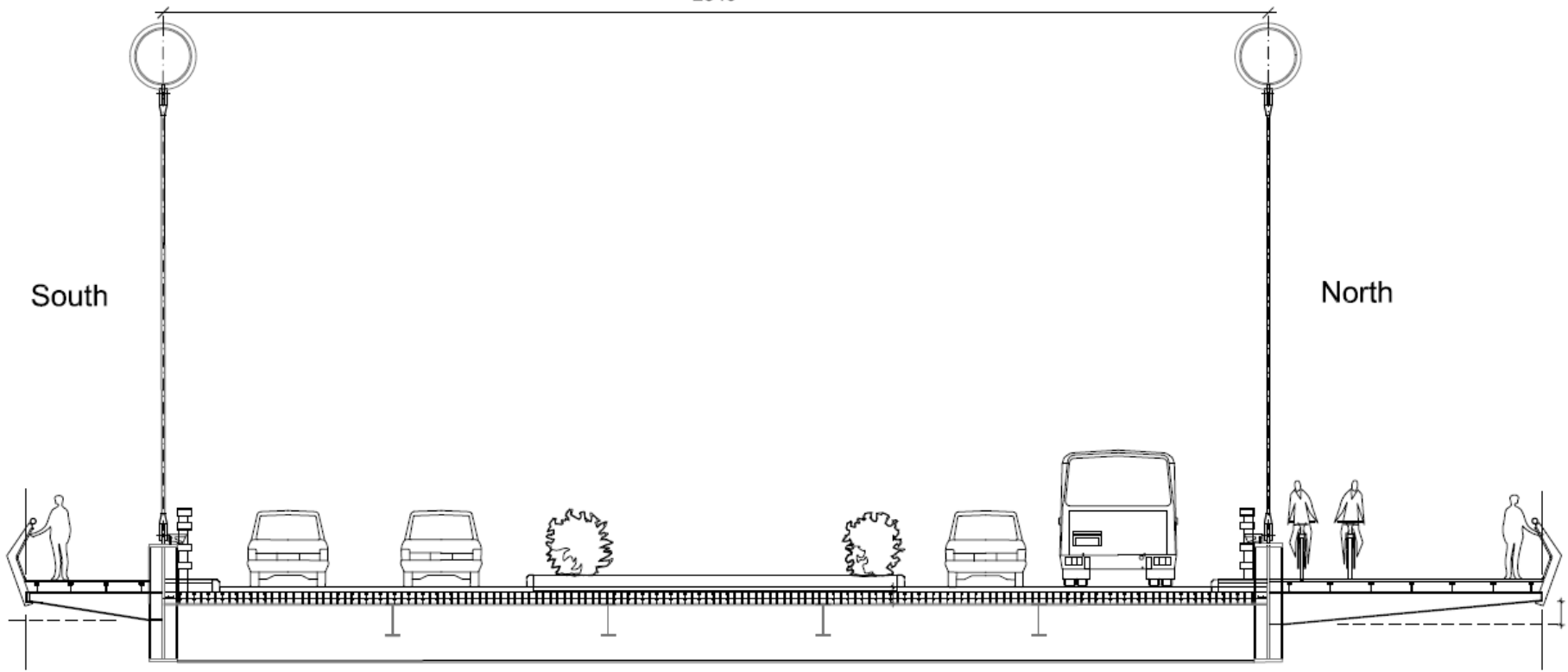



סכמה הנדסית - אנכי

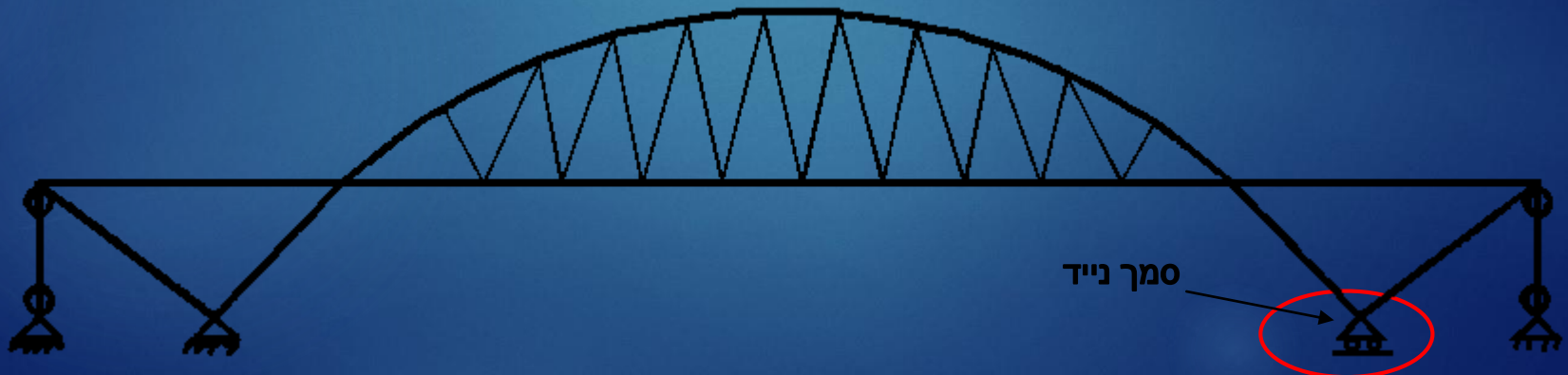
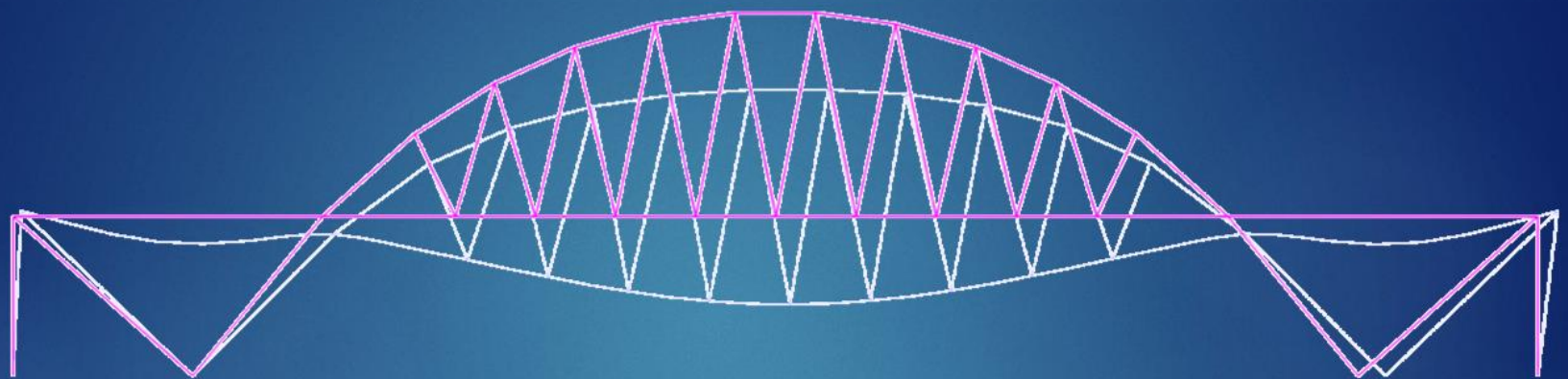

סכמה הנדסית - אורכי

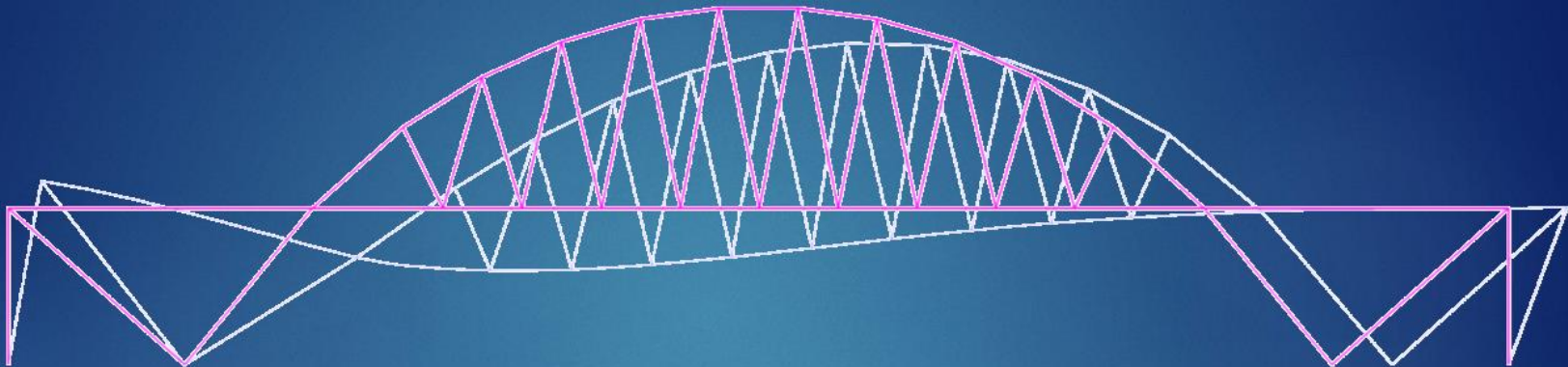

סמך נייד

סכמה הנדסית - רוחבי

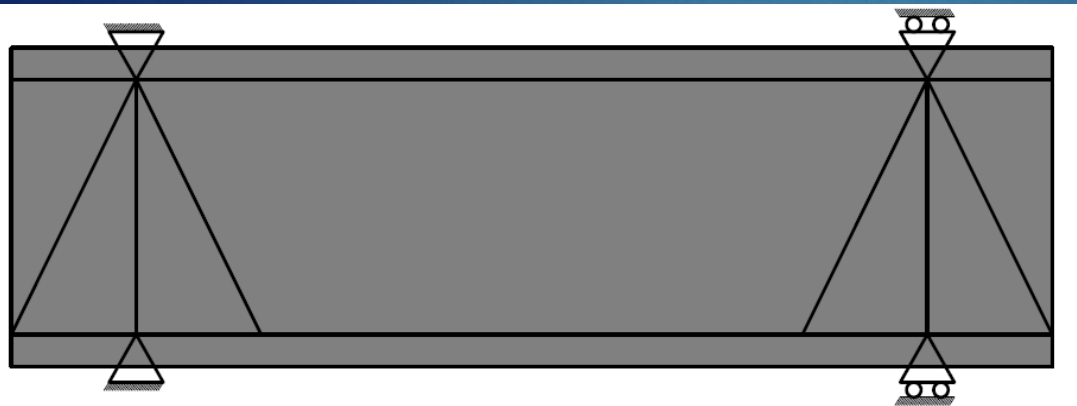

Spherical Bearing

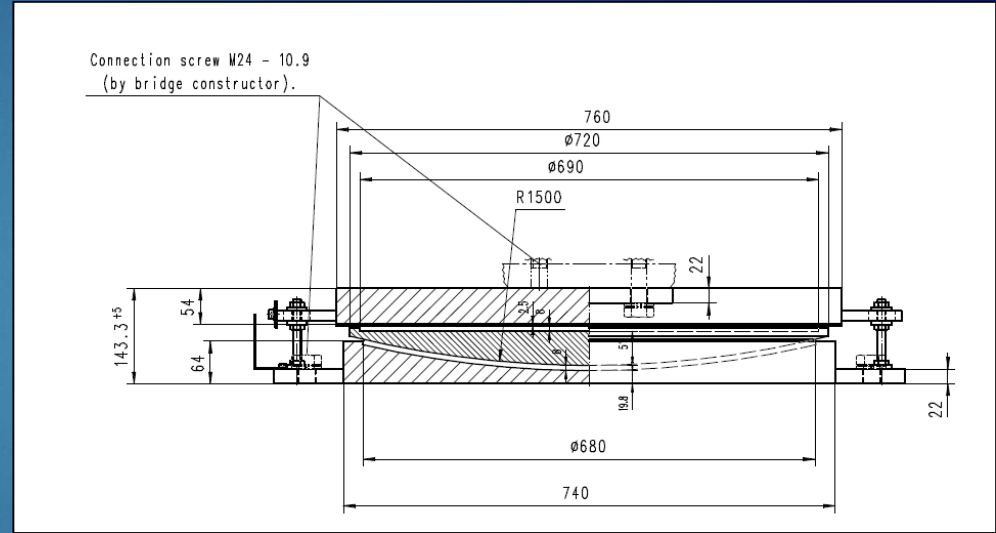

אנליזות

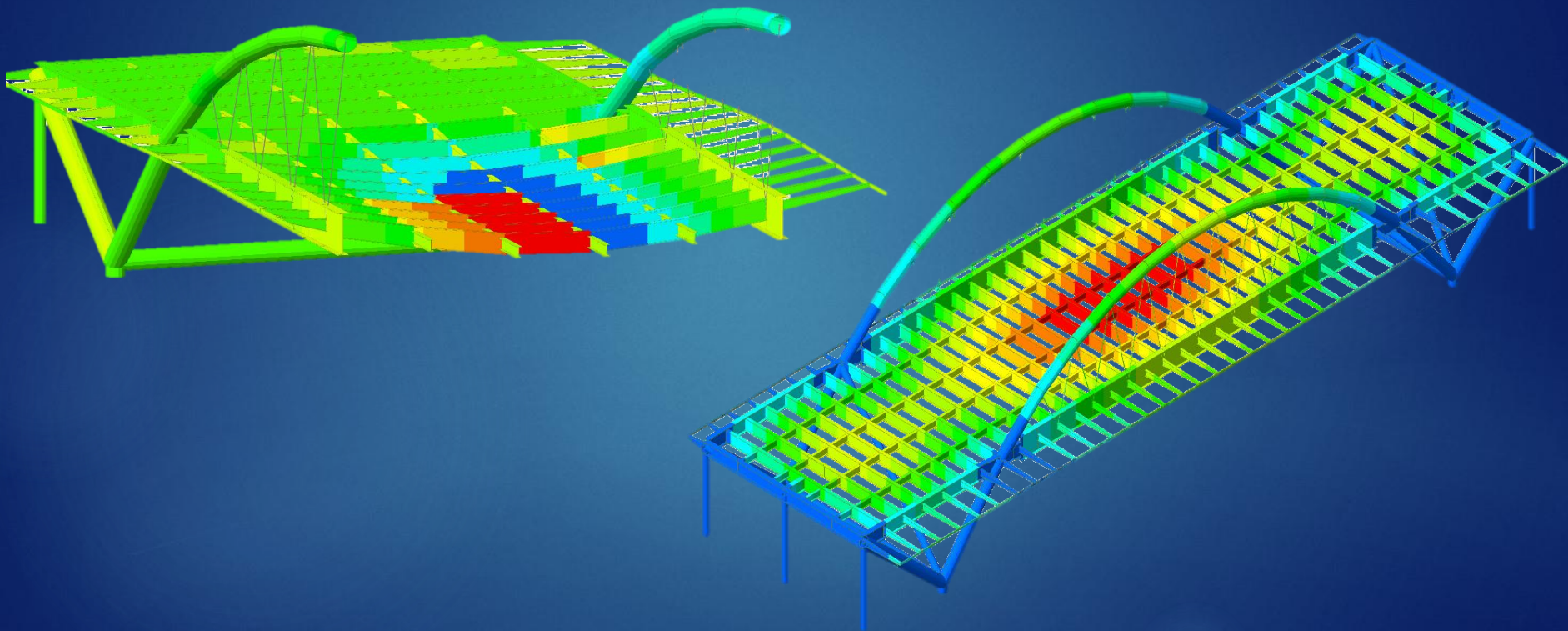

תכן מחברים

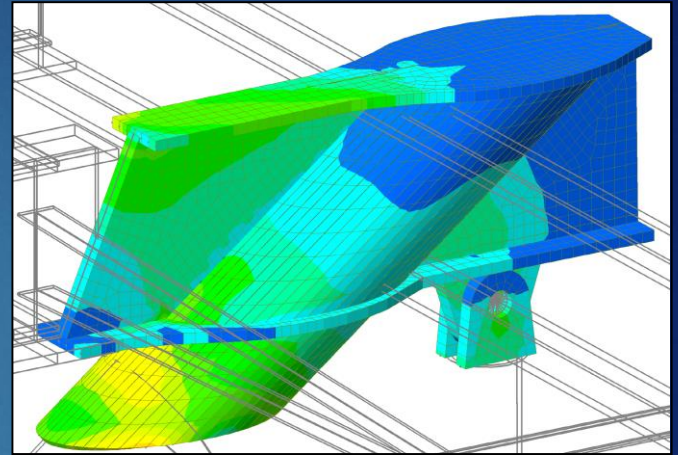
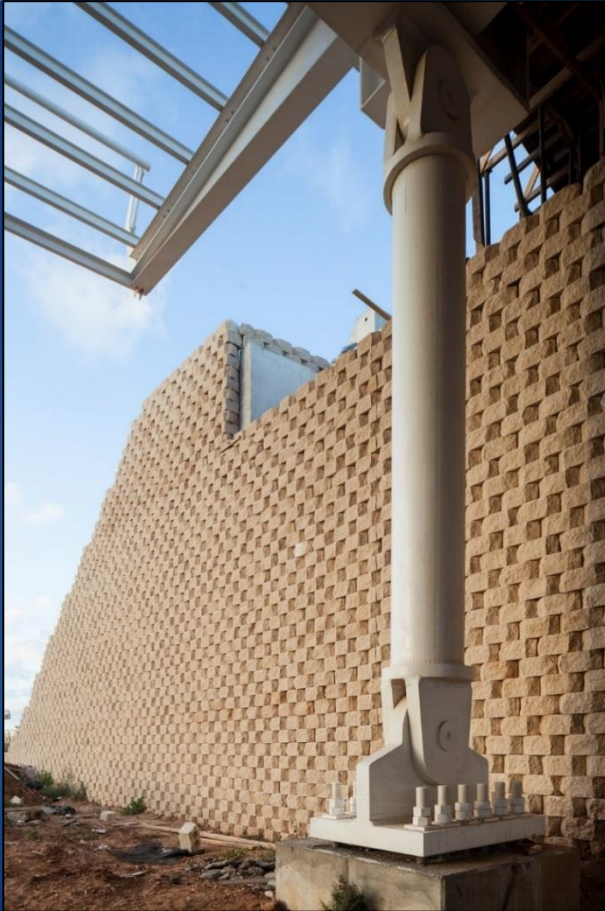

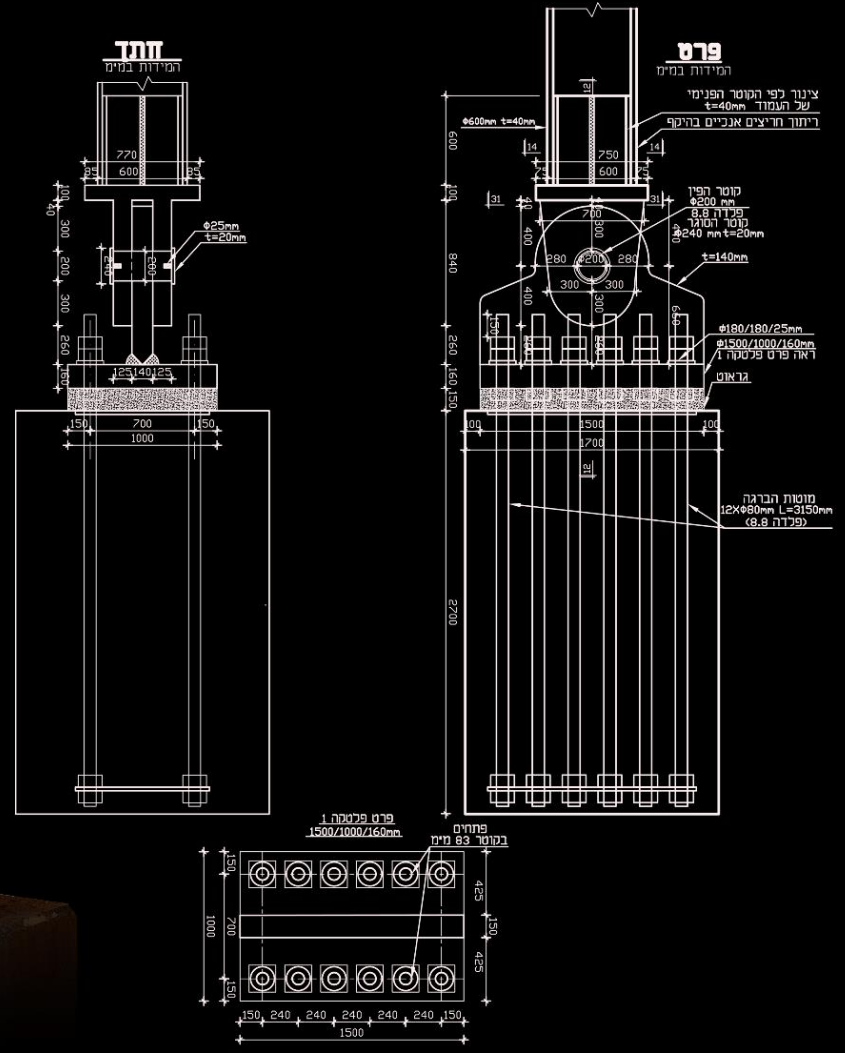

חיבור קשת מוטות מתיחה

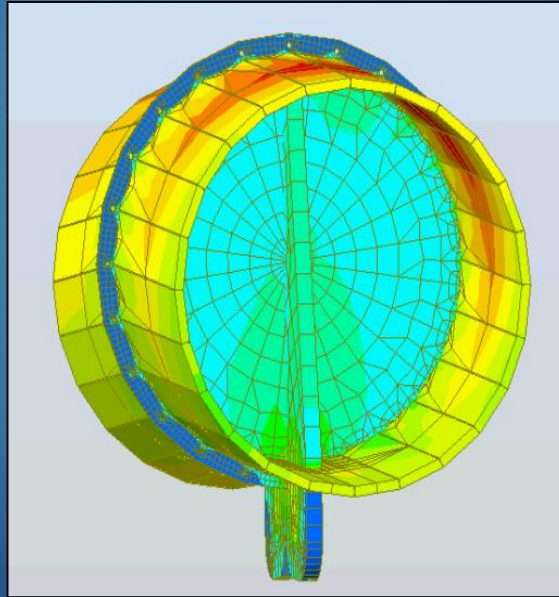
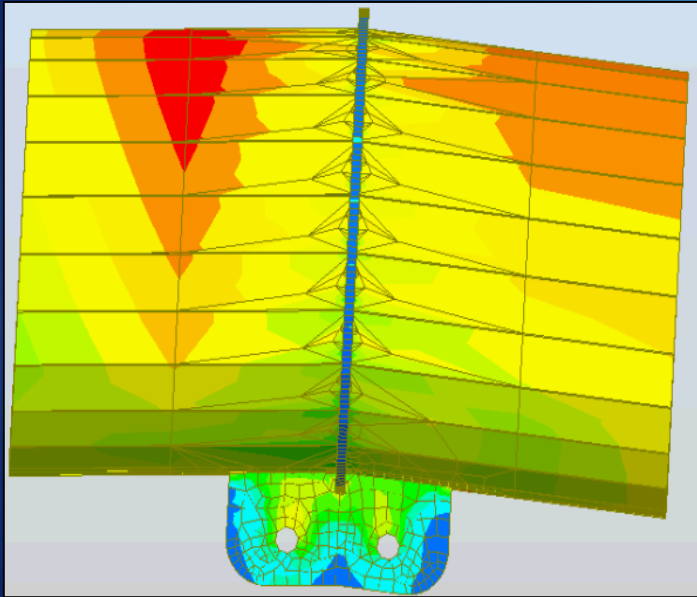

חיבור קשת לקורה ראשית



חיבור קשת לקורה ראשית

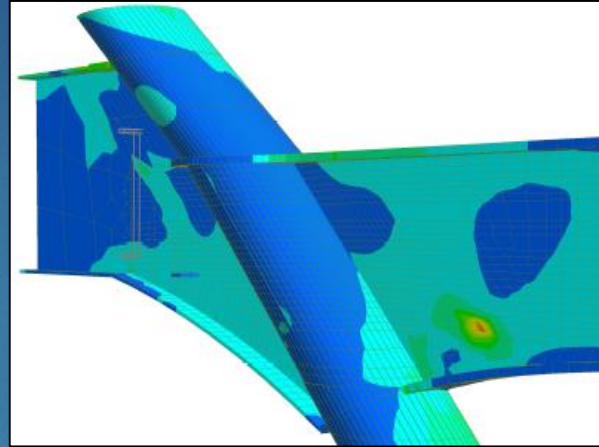
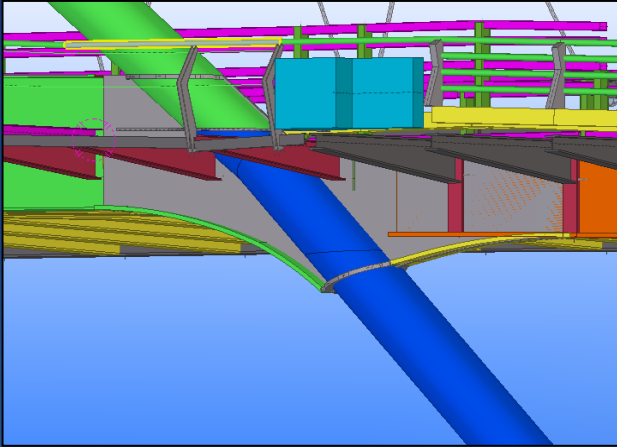

אנליזות קריסה

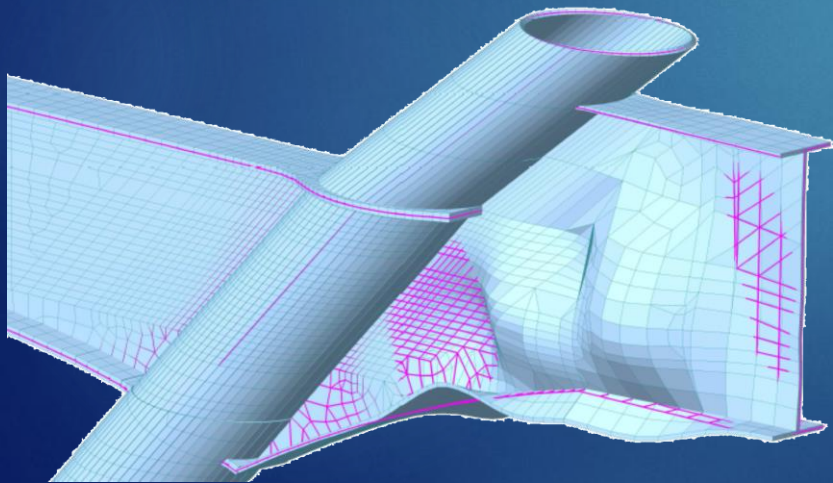
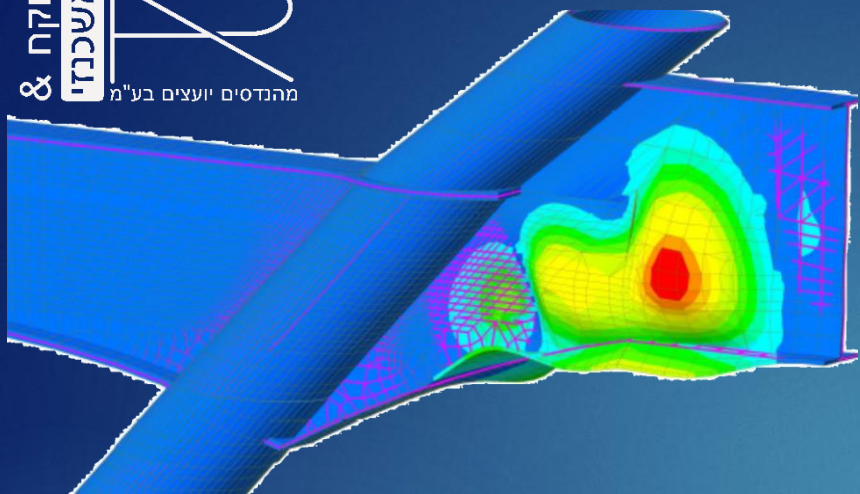

אנליזות קריסה

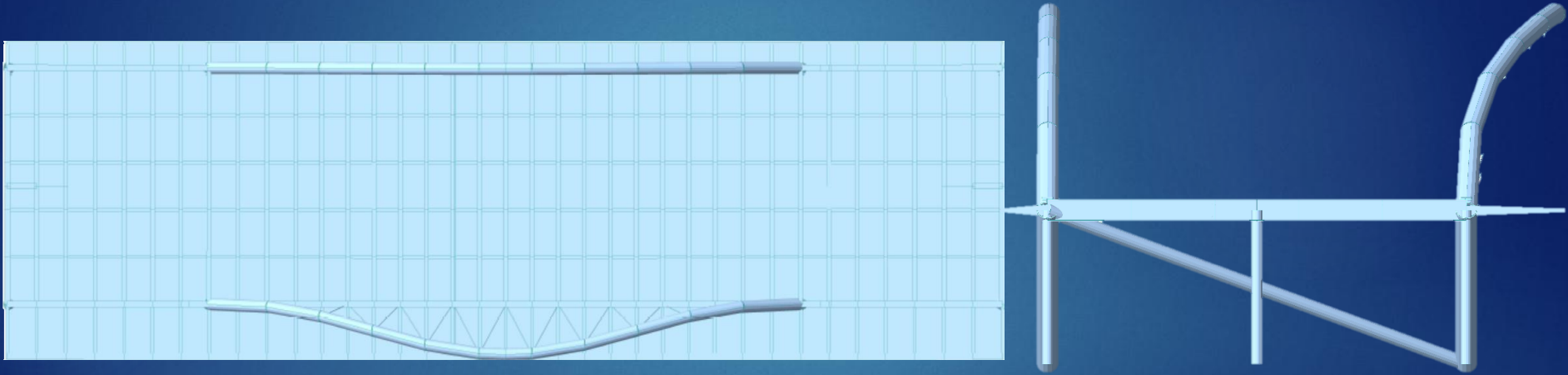

אנליזות קריסה

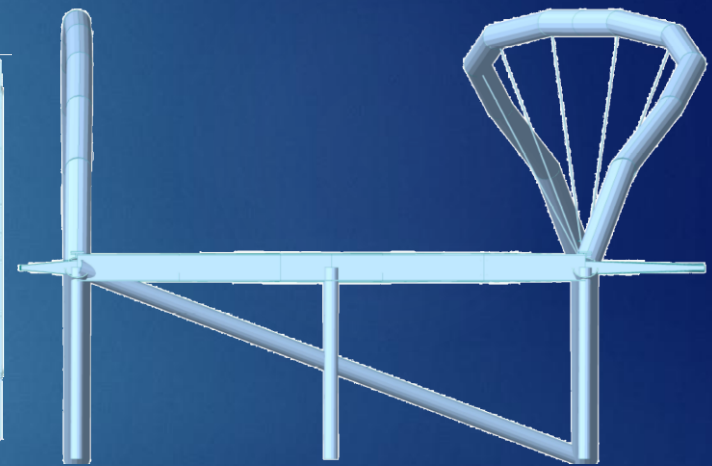
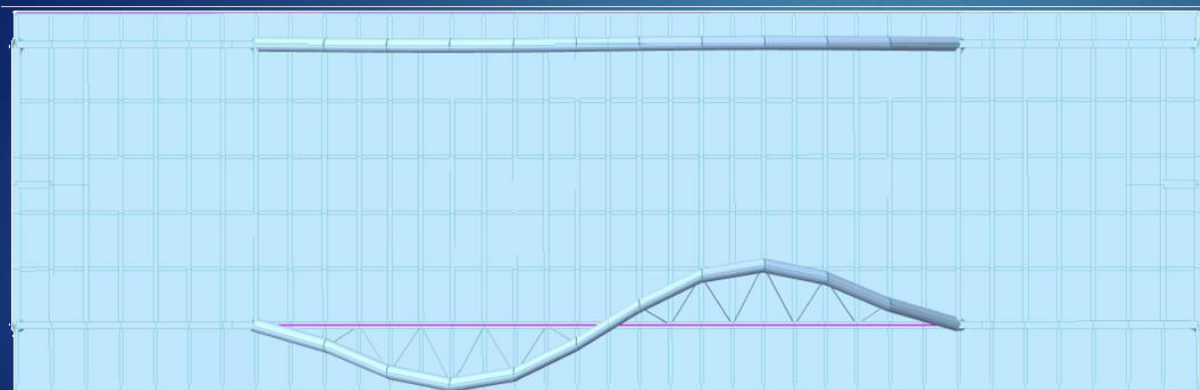

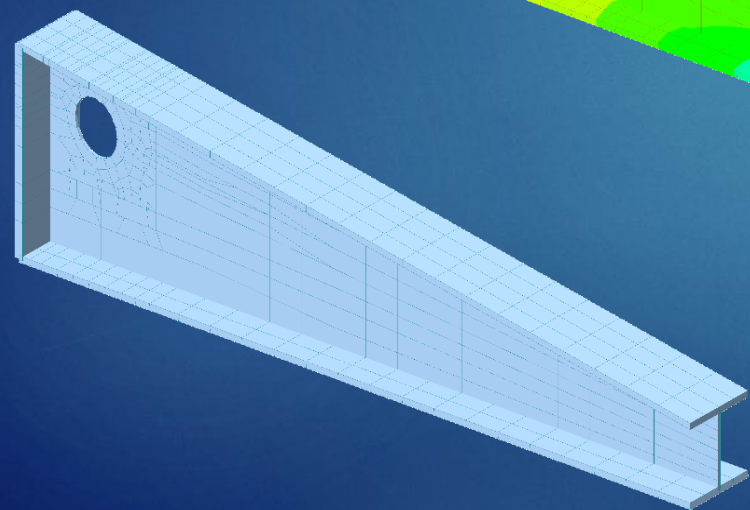
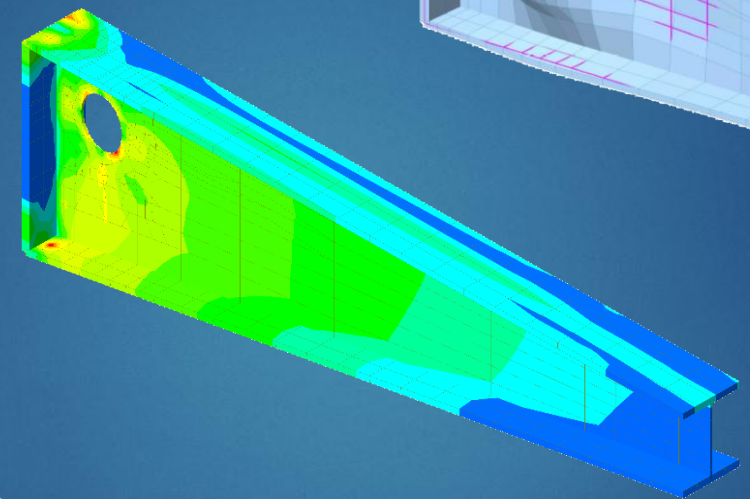
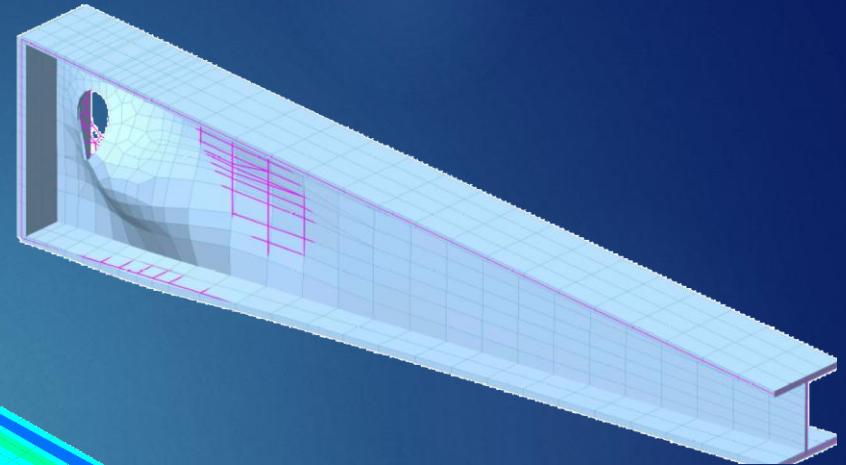

עקומי קריסה תקניים מול קריסת אויילר

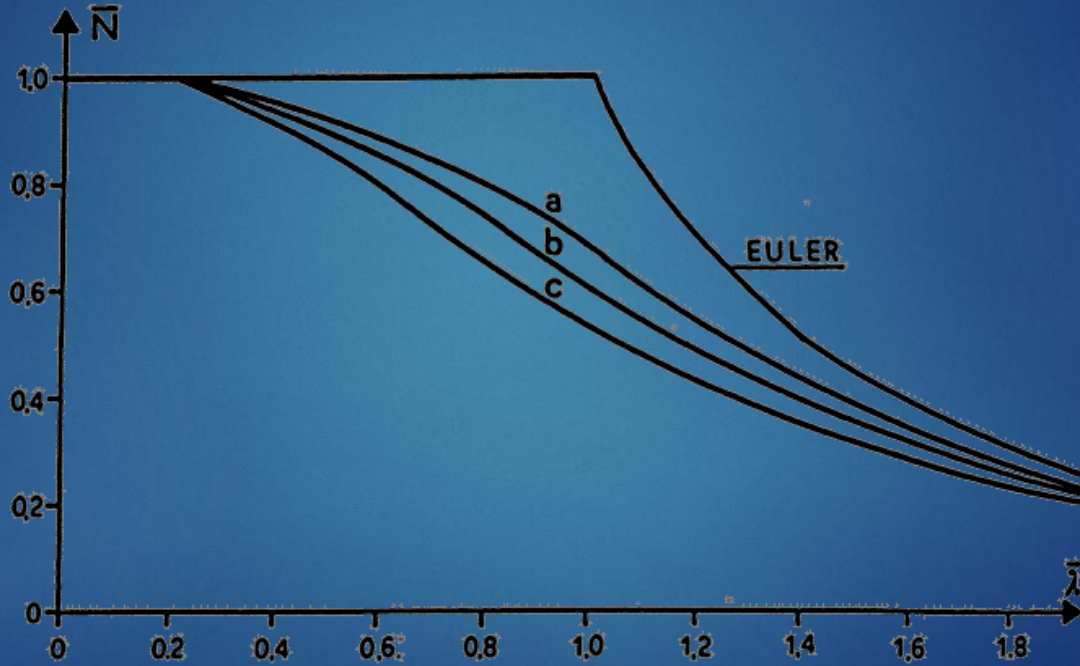

תכנון לרעידת אדמה

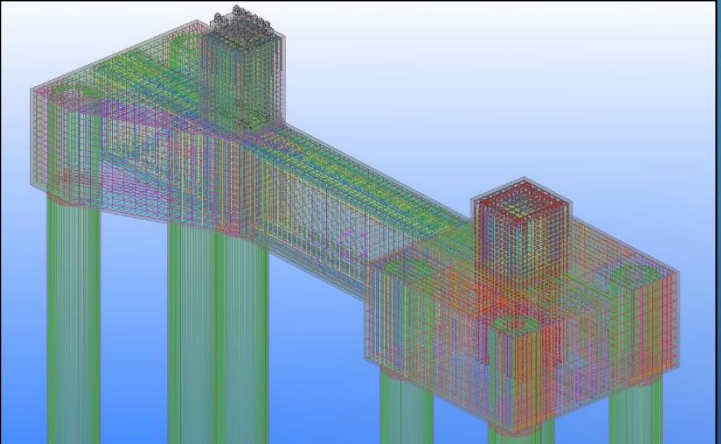
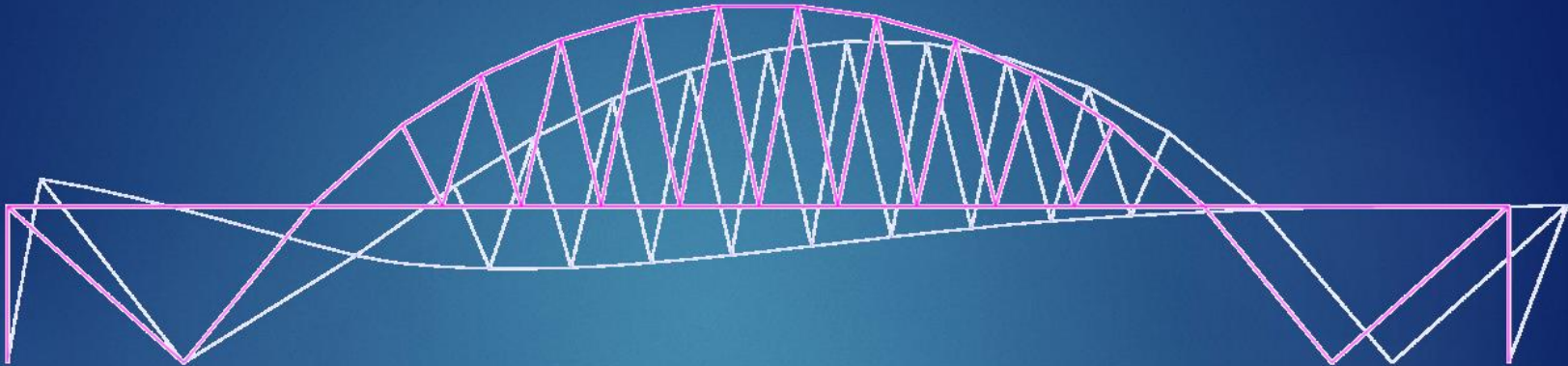

Sa [g]

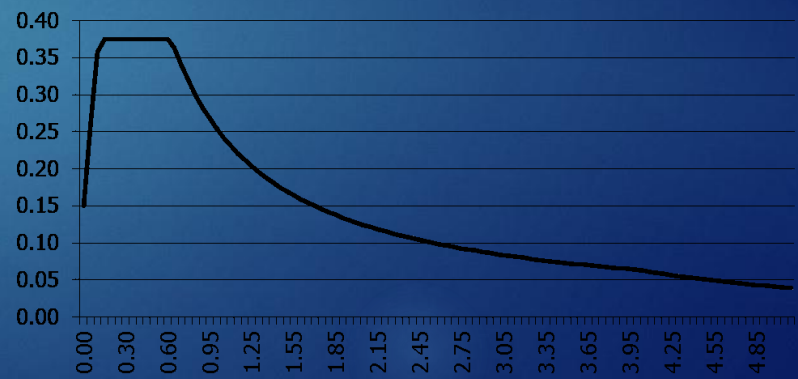

תכנון לרעידת אדמה

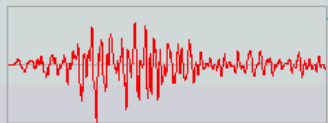
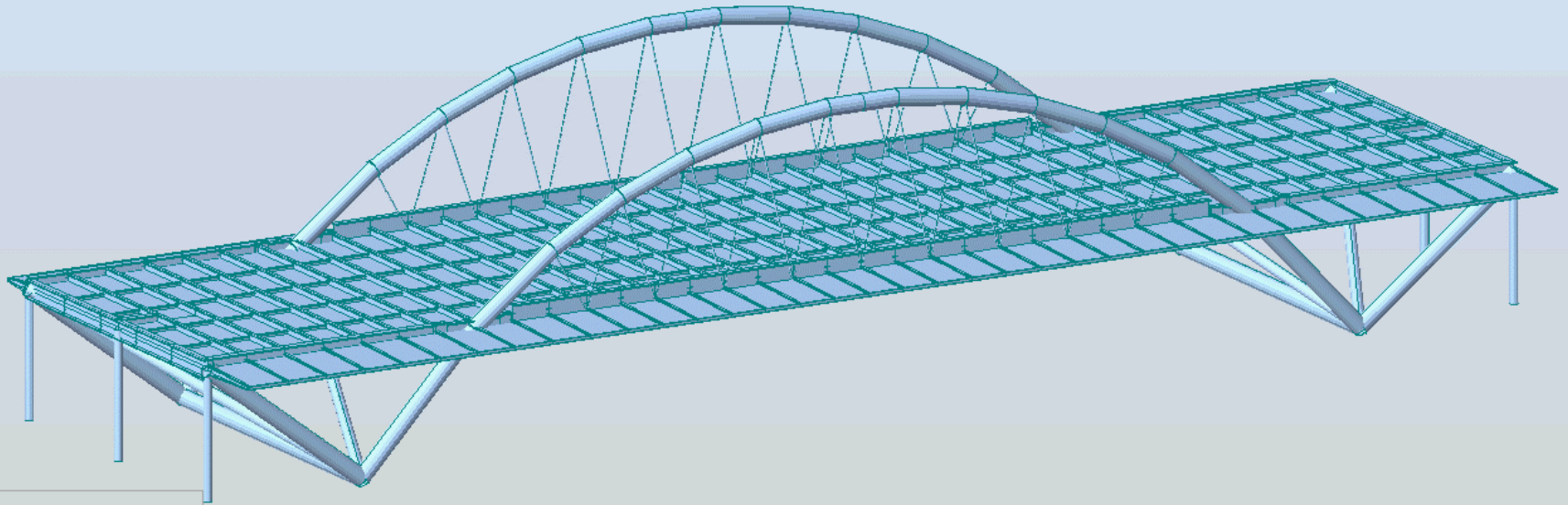

**Time Step : 0.01

תכנון לרעידת אדמה

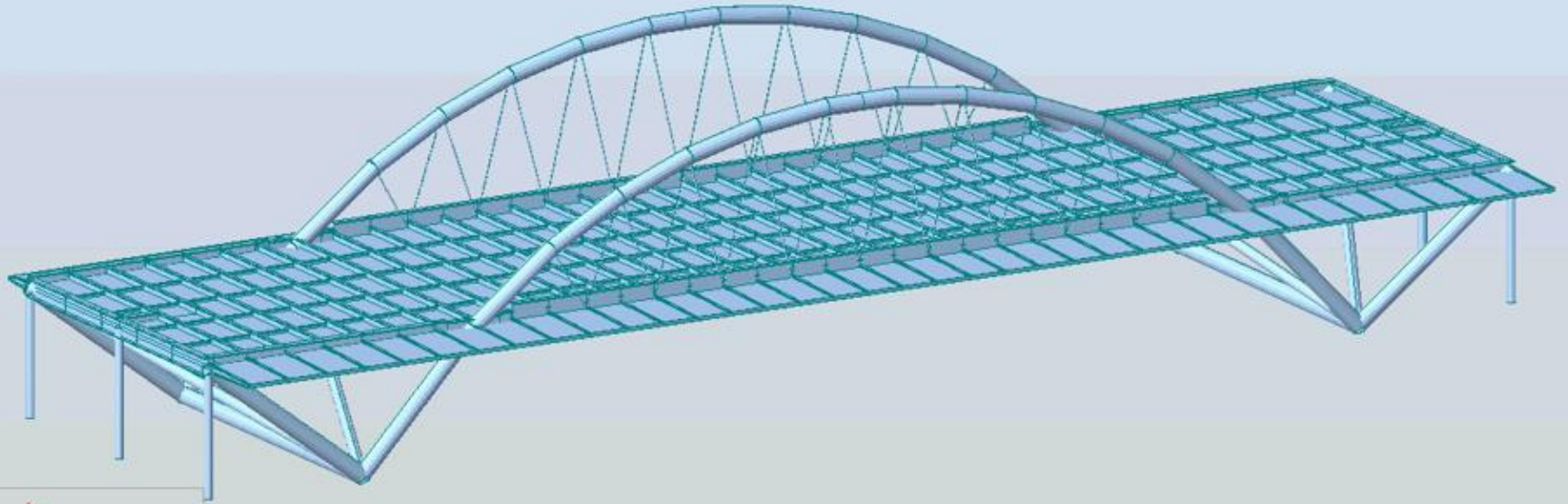

שלבי ביצוע

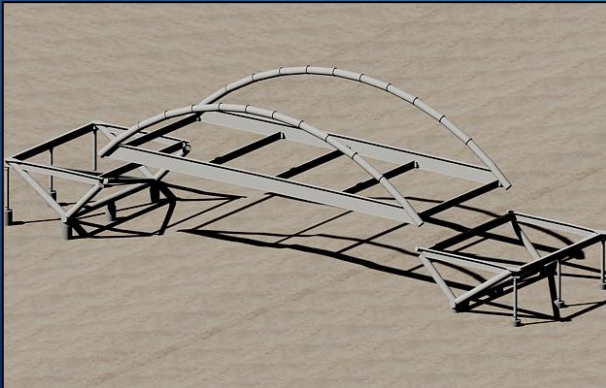
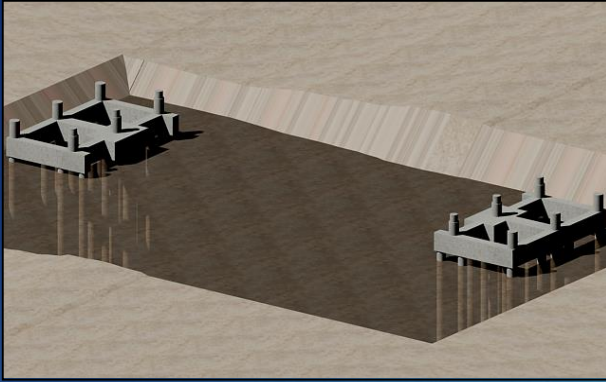

שלבי ביצוע בפועל

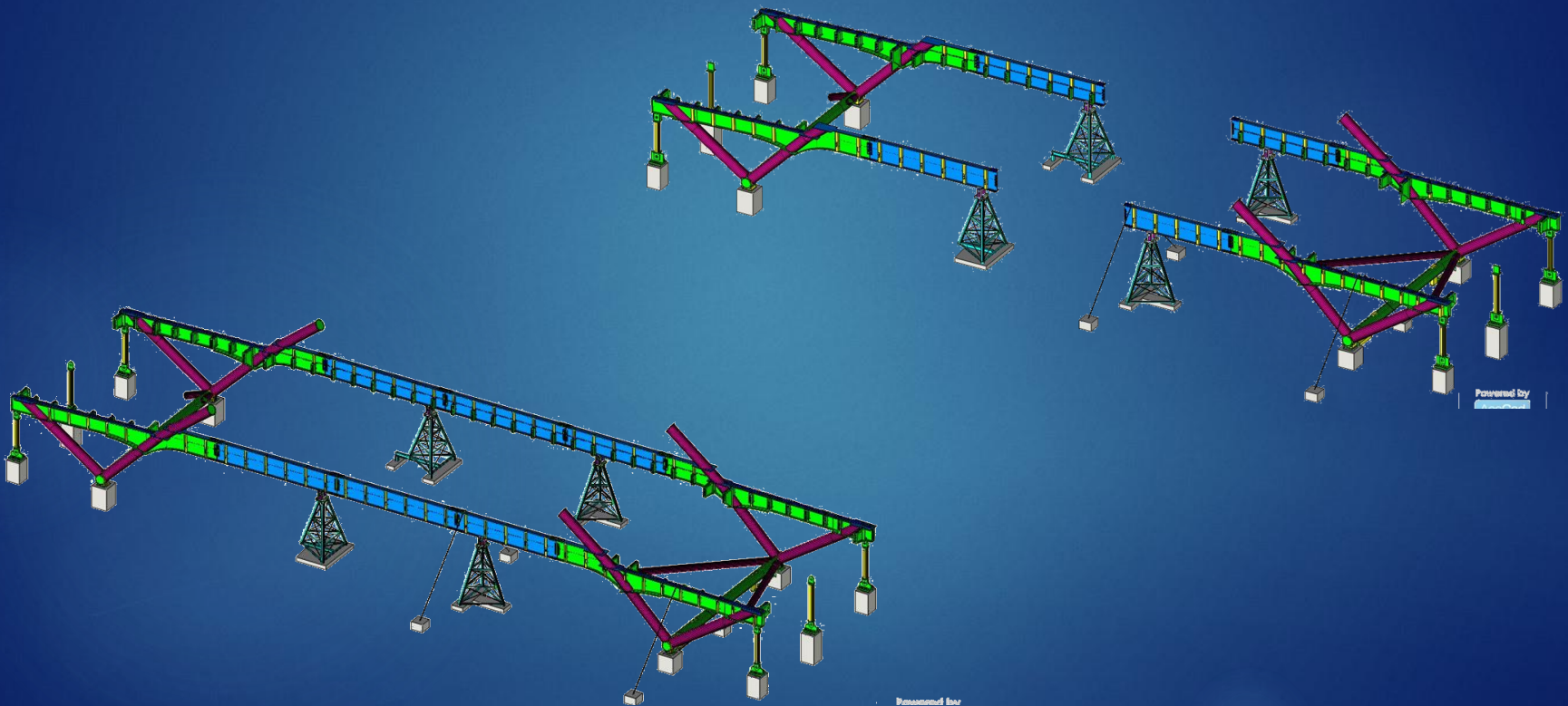

Powered by

Powered by

הרכבת חלקי הגשר

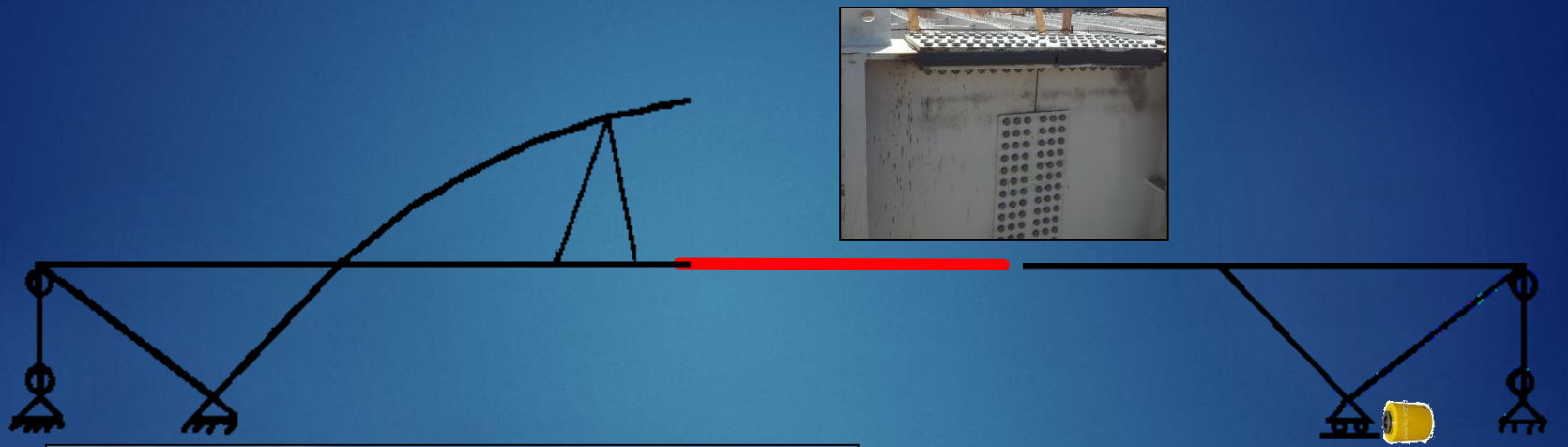

תמונות משלבי הביצוע



תמונות משלבי הביצוע

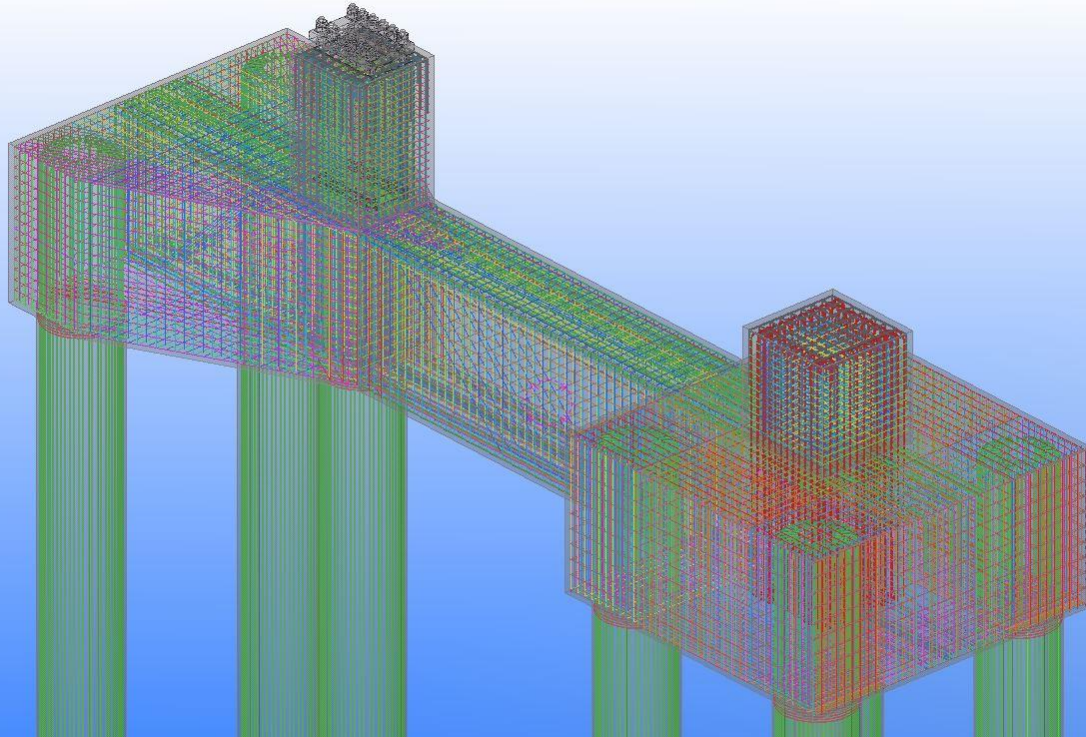

תמונות משלבי הביצוע



תמונות משלבי הביצוע



תמונות משלבי הביצוע





תמונות משלבי הביצוע



תמונות משלבי הביצוע



תמונות משלבי הביצוע

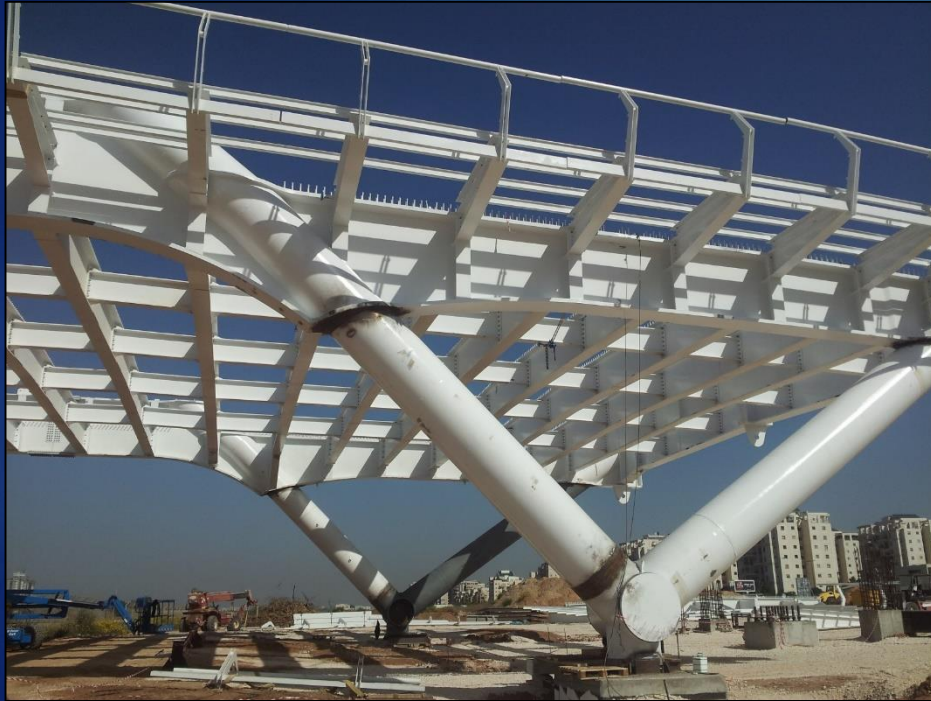

תמונות משלבי הביצוע



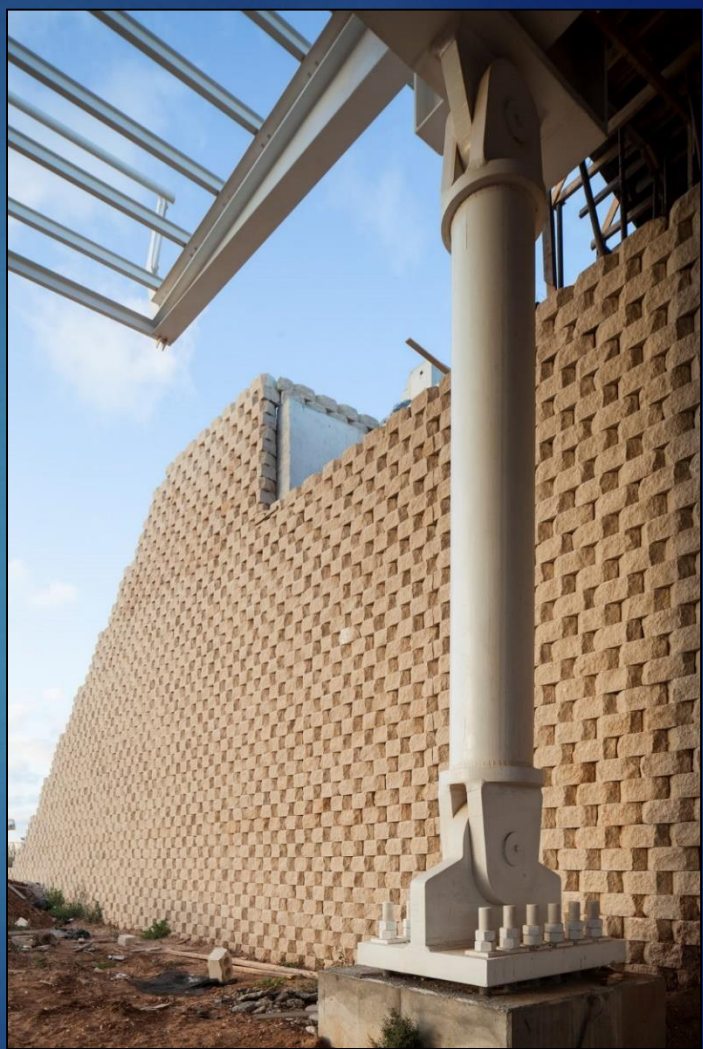

תמונות משלבי הביצוע



תמונות משלבי הביצוע



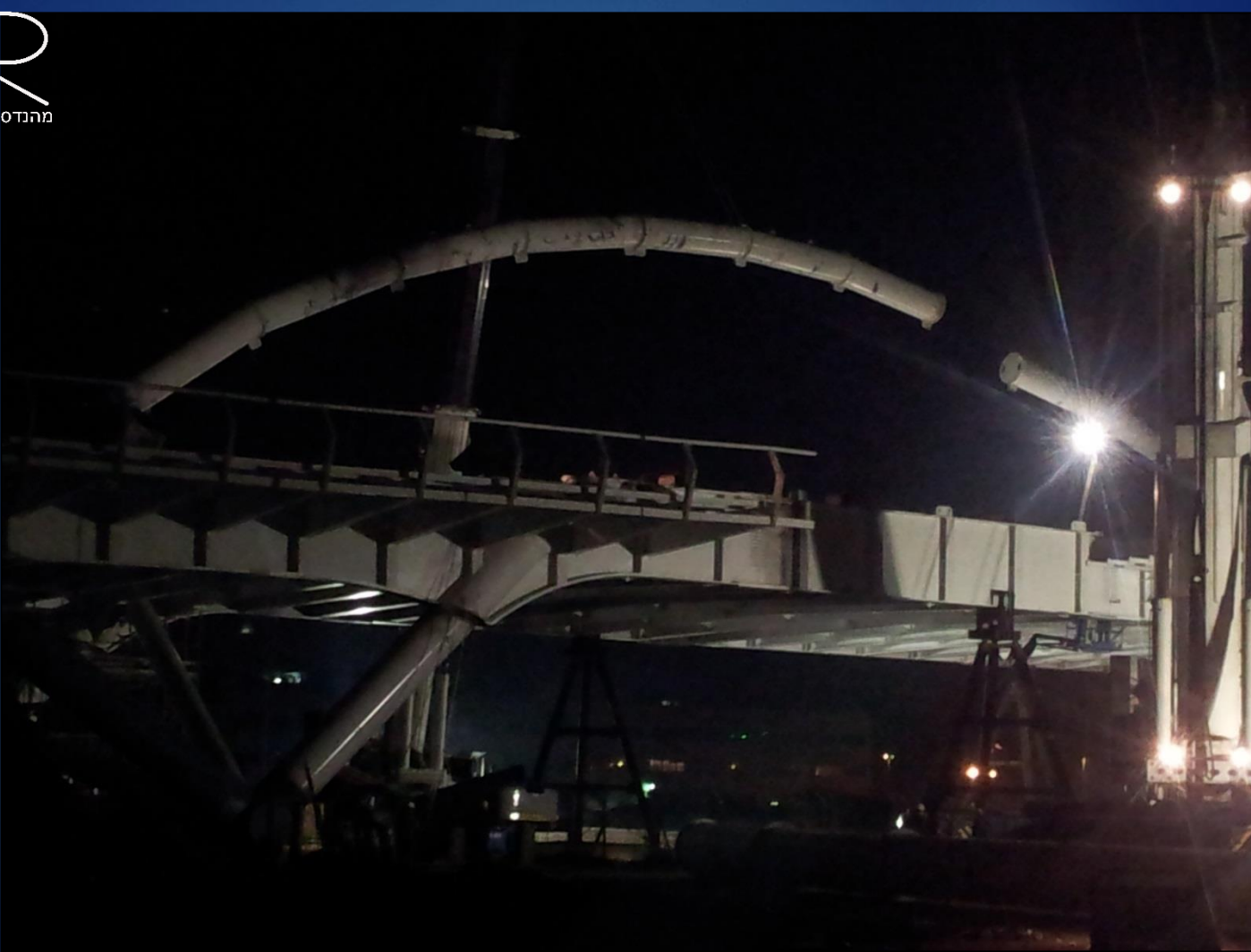

תמונות משלבי הביצוע

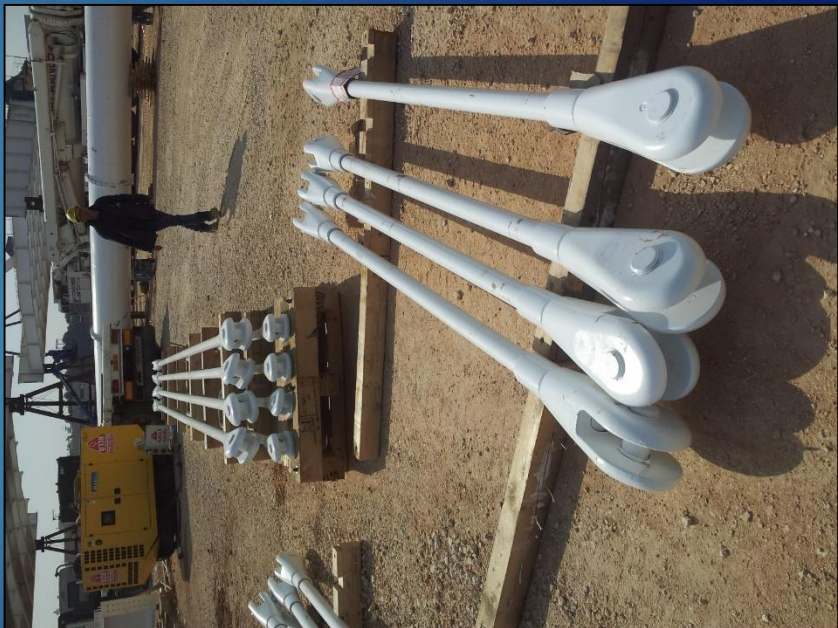

תמונות משלבי הביצוע





תמונות משלבי הביצוע













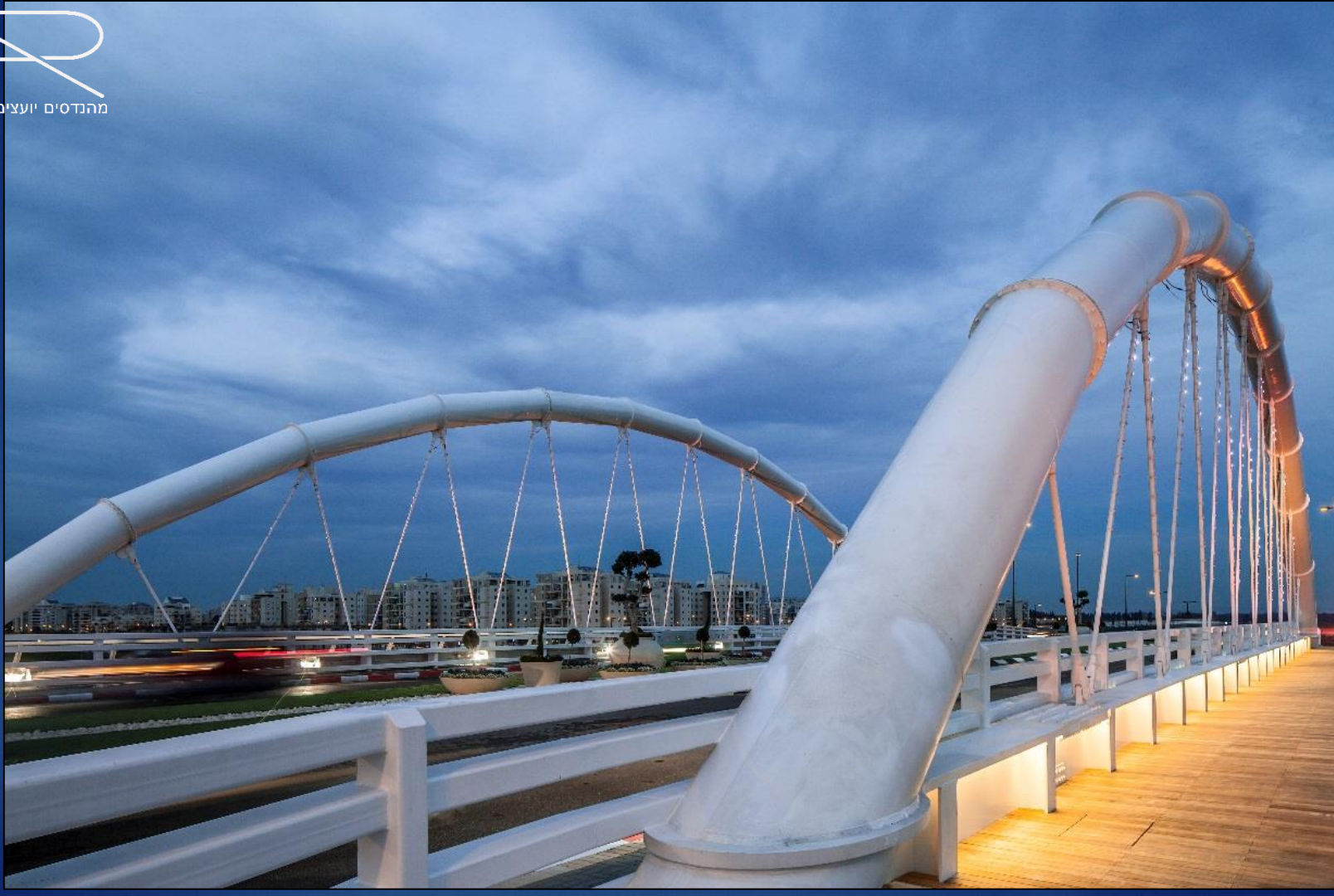

ron

N

